

MAX2612–MAX2616

40MHz至4GHz宽带线性放大器

概述

MAX2612–MAX2616为高性能宽带放大器，设计用于功放(PA)的前级驱动、低噪声放大器或可级联的50Ω放大器，输出功率高达+19.5dBm。器件适用于多种应用，包括蜂窝基础设施、个人或商用微波无线设备，以及CATV和电缆调制解调器，工作频率范围为40MHz至4000MHz。放大器采用+3V至+5.25V电源供电，内部提供输入和输出端口的50Ω匹配。该系列器件引脚互相兼容，采用紧凑的2mm x 3mm TDFN无铅封装。

应用

蜂窝基础设施
 微波无线设备
 无线LAN
 测试和测量

订购信息在数据资料的最后给出。

相关型号以及配合该器件使用的推荐产品，请参见：china.maximintegrated.com/MAX2612.related。

特性

- 非常平坦的频率响应
 - ◇ $< 0.5\text{dB}$, 1GHz至4GHz
- 低噪声: 2.0dB ($f_{\text{RFIN}} = 2.0\text{GHz}$)
- 40MHz至4000MHz工作频率范围
- 具有业内最高的 P_{IN} (最大值)额定值
- 较高的OIP3范围
 - ◇ MAX2615/MAX2616: +37dBm
 - ◇ MAX2612: +35.2dBm
 - ◇ MAX2613: +31.2dBm
 - ◇ MAX2614: +30dBm
- 输出P1dB: +19.5dBm (MAX2615/MAX2616)
- 高增益: 18.6dB
- 关断模式(MAX2612/MAX2613/MAX2614/MAX2616)
- 可调偏置电流，改善OIP3 (MAX2615)
- 3.0V至5.25V供电范围
- 紧凑的2mm x 3mm TDFN封装
- 业内较高的ESD等级: 2.5kV HBM

典型应用电路

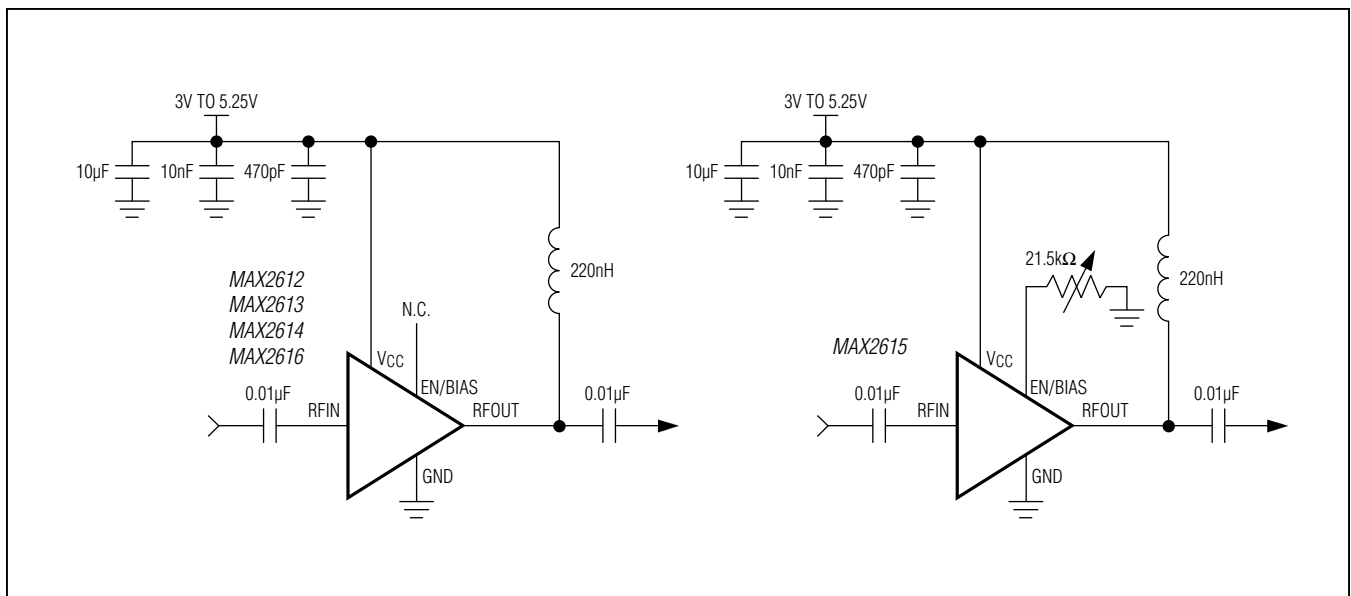

本文是英文数据资料的译文，文中可能存在翻译上的不准确或错误。如需进一步确认，请在您的设计中参考英文资料。有关价格、供货及订购信息，请联络Maxim亚洲销售中心：10800 852 1249 (北中国区)，10800 152 1249 (南中国区)，或访问Maxim的中文网站：china.maximintegrated.com。

MAX2612–MAX2616

40MHz至4GHz宽带线性放大器

ABSOLUTE MAXIMUM RATINGS

V_{CC,EN/RBIAS, RFOUT} to GND-0.3V to +6.0V
 Maximum Input Power (RFIN) +20dBm
 Continuous Power Dissipation (T_A = +70°C)
 TDFN (derates 16.7mW/°C above +70°C)..... 1333.3mW
 Operating Temperature Range..... -40°C to +85°C

Junction Temperature+150°C
 Storage Temperature Range.....-65°C to +160°C
 Lead Temperature (soldering, 10s)+300°C
 Soldering Temperature (reflow)+260°C

Stresses beyond those listed under "Absolute Maximum Ratings" may cause permanent damage to the device. These are stress ratings only, and functional operation of the device at these or any other conditions beyond those indicated in the operational sections of the specifications is not implied. Exposure to absolute maximum rating conditions for extended periods may affect device reliability.

PACKAGE THERMAL CHARACTERISTICS (Note 1)

TDFN

Junction-to-Ambient Thermal Resistance (θ_{JA})60°C/W Junction-to-Case Thermal Resistance (θ_{JC})11°C/W

Note 1: Package thermal resistances were obtained using the method described in JEDEC specification JESD51-7, using a four-layer board. For detailed information on package thermal considerations, refer to china.maximintegrated.com/thermal-tutorial.

DC ELECTRICAL CHARACTERISTICS

(MAX2612/MAX2613/MAX2614/MAX2615/MAX2616 EV Kit, V_{CC} = +5.0V, no RF input signals at RFIN, T_A = -40°C to +85°C, unless otherwise noted. Typical values are at V_{RFOUT} = +5V, T_A = +25°C, unless otherwise noted.) (Note 2)

PARAMETER	CONDITIONS	MIN	TYP	MAX	UNITS
Supply Voltage	DC voltage at RFOUT	3	5	5.25	V
Supply Current	MAX2612		69		mA
	MAX2613		51.2		
	MAX2614		40.6		
	MAX2615, R _{BIAS} = 21.5kΩ		81.5		
	MAX2616		80.6		
Shutdown Supply Current	EN logic-low		7		μA
RBIAS Minimum	MAX2615		10		kΩ

AC ELECTRICAL CHARACTERISTICS

(MAX2612/MAX2613/MAX2614/MAX2615/MAX2616 EV Kit, V_{CC} = +5V, T_A = -40°C to +85°C, unless otherwise noted. Typical values are at V_{RFOUT} = +5V, T_A = +25°C, unless otherwise noted.) (Note 2)

PARAMETER	CONDITIONS		MIN	TYP	MAX	UNITS
RFIN Frequency Range			40		4000	MHz
Power Gain	f _{RFIN} = 1000MHz (Note 3)	MAX2612		18.3		dB
		MAX2613		18.6		
		MAX2614		18.6		
		MAX2615		18.5		
		MAX2616		18.4		
	f _{RFIN} = 4000MHz (Note 3)	MAX2612		17.5		
		MAX2613		18.1		
		MAX2614		17.5		
		MAX2615		18.0		
		MAX2616		18.0		

MAX2612–MAX2616

40MHz至4GHz宽带线性放大器

AC ELECTRICAL CHARACTERISTICS (continued)

(MAX2612/MAX2613/MAX2614/MAX2615/MAX2616 EV Kit, $V_{CC} = +5V$, $T_A = -40^{\circ}C$ to $+85^{\circ}C$, unless otherwise noted. Typical values are at $V_{RFOUT} = +5V$, $T_A = +25^{\circ}C$, unless otherwise noted.) (Note 2)

PARAMETER	CONDITIONS		MIN	TYP	MAX	UNITS
Gain Flatness Across Band	$f_{RFIN} = 1000MHz < f_{RFOUT} < 3000MHz$ (Note 3)	MAX2612		0.2		dB
		MAX2613		0.1		
		MAX2614		0.15		
		MAX2615		0.15		
		MAX2616		0.1		
	$f_{RFIN} = 1000MHz < f_{RFOUT} < 4000MHz$ (Note 3)	MAX2612		0.8		
		MAX2613		0.5		
		MAX2614		1.1		
		MAX2615		0.5		
		MAX2616		0.4		
Noise Figure	$f_{RFIN} = 2000MHz$ (Note 3)	MAX2612		2.1	2.65	dB
		MAX2613		2	2.42	
		MAX2614		2	2.35	
		MAX2615		2.2	2.95	
		MAX2616		2.2	2.85	
OIP3	Input tones at 1000MHz and 1001MHz at -15dBm/tone	MAX2612		35.2		dBm
		MAX2613		31.2		
		MAX2614		29.7		
		MAX2615		37.6		
		MAX2616		37.2		
Output P1dB	$f_{RFIN} = 1000MHz$ (Note 3)	MAX2612		18.2		dBm
		MAX2613		15.5		
		MAX2614		13.6		
		MAX2615		19.5		
		MAX2616		19.5		
Reverse Isolation	$40MHz < f_{RFOUT} < 4000MHz$			20		dB
RFIN Input Return Loss	$40MHz < f_{RFOUT} < 1000MHz$	MAX2612		15		dB
		MAX2613		15		
		MAX2614		12		
		MAX2615		15		
		MAX2616		15		
	$1000MHz < f_{RFOUT} < 4000MHz$	MAX2612		12		
		MAX2613		8		
		MAX2614		8		
		MAX2615		12		
		MAX2616		12		

MAX2612–MAX2616

40MHz至4GHz宽带线性放大器

AC ELECTRICAL CHARACTERISTICS (continued)

(MAX2612/MAX2613/MAX2614/MAX2615/MAX2616 EV Kit, $V_{CC} = +5V$, $T_A = -40^{\circ}C$ to $+85^{\circ}C$, unless otherwise noted. Typical values are at $V_{RFOUT} = +5V$, $T_A = +25^{\circ}C$, unless otherwise noted.) (Note 2)

PARAMETER	CONDITIONS	MIN	TYP	MAX	UNITS
RFOUT Output Return Loss	$40MHz < f_{RFOUT} < 1000MHz$	MAX2612		20	dB
		MAX2613		15	
		MAX2614		12	
		MAX2615		20	
		MAX2616		20	
	$1000MHz < f_{RFOUT} < 4000MHz$	MAX2612		12	
		MAX2613		10	
		MAX2614		10	
		MAX2615		12	
		MAX2616		12	

Note 2: Min and max values are production tested at $T_A = +85^{\circ}C$. Min and max limits at $T_A = +25^{\circ}C$ and $T_A = -40^{\circ}C$ are guaranteed by design and characterization.

Note 3: Min and max values are guaranteed by design and characterization at $T_A = +25^{\circ}C$.

典型工作特性

(MAX2612/MAX2613/MAX2614/MAX2615/MAX2616 EV Kit, $V_{RFOUT} = +5V$, $T_A = +25^{\circ}C$.)

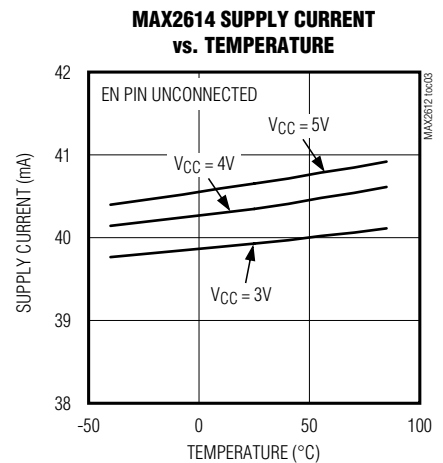
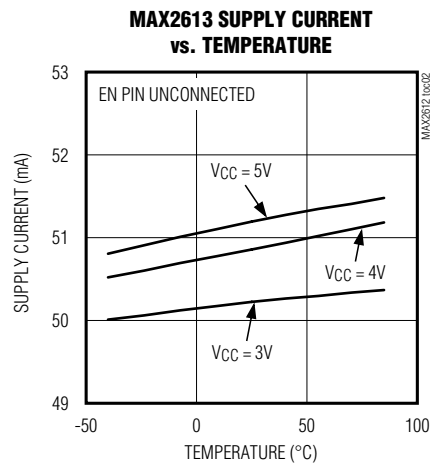
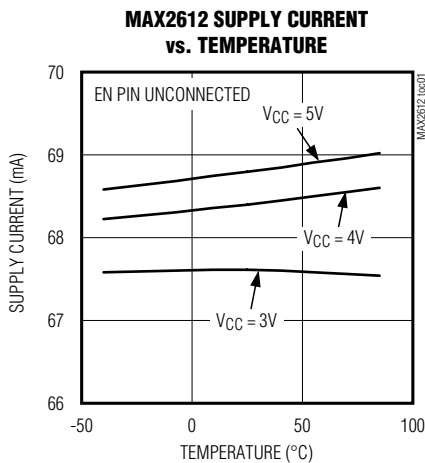

MAX2612-MAX2616

40MHz至4GHz宽带线性放大器

典型工作特性(续)

(MAX2612/MAX2613/MAX2614/MAX2615/MAX2616 EV Kit, $V_{RFOUT} = +5V$, $T_A = +25^{\circ}C$.)

MAX2615 SUPPLY CURRENT vs. TEMPERATURE

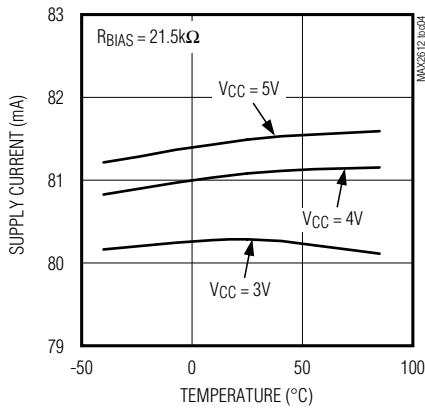

MAX2616 SUPPLY CURRENT vs. TEMPERATURE

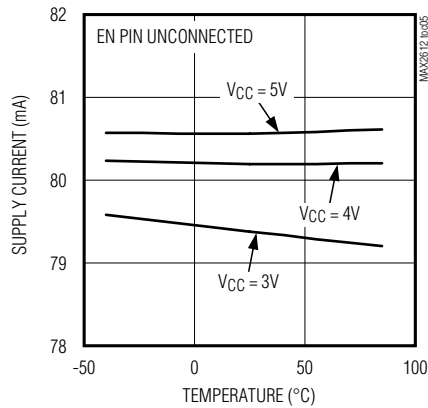

MAX2612 GAIN vs. FREQUENCY

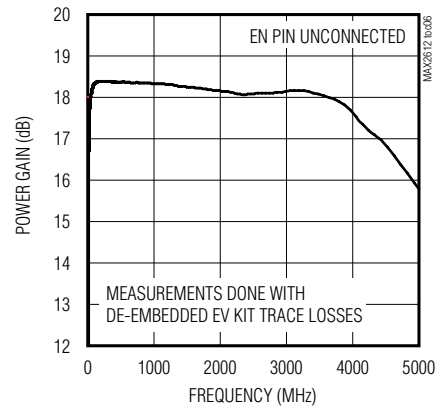

MAX2613 GAIN vs. FREQUENCY

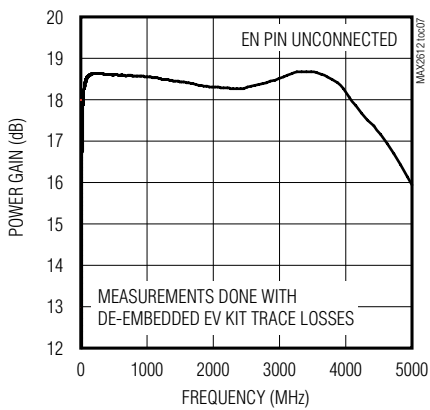

MAX2614 GAIN vs. FREQUENCY

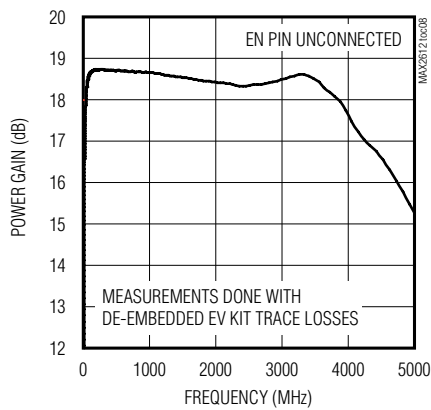

MAX2615 GAIN vs. FREQUENCY

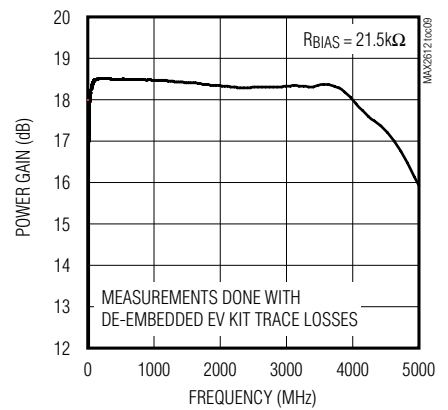

MAX2616 GAIN vs. FREQUENCY

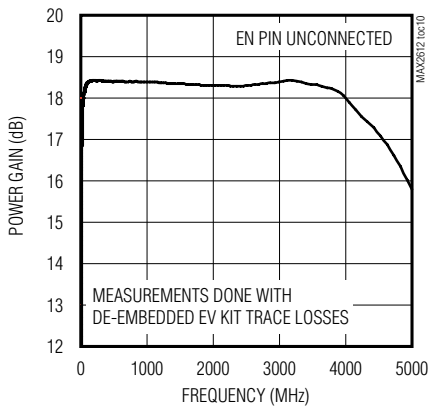

MAX2612 GAIN vs. TEMPERATURE

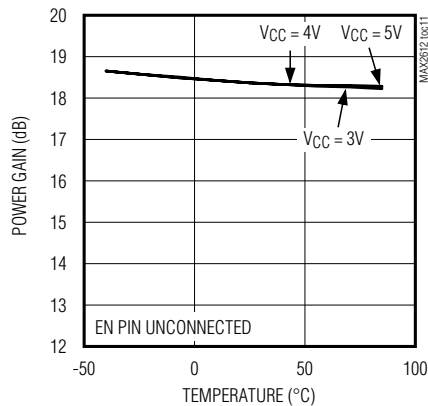

MAX2613 GAIN vs. TEMPERATURE

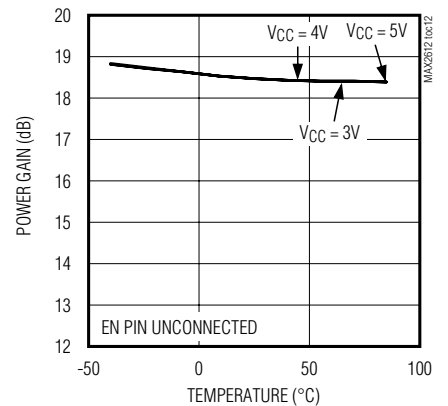

MAX2612-MAX2616

40MHz至4GHz宽带线性放大器

典型工作特性(续)

(MAX2612/MAX2613/MAX2614/MAX2615/MAX2616 EV Kit, $V_{RFOUT} = +5V$, $T_A = +25^\circ C$.)

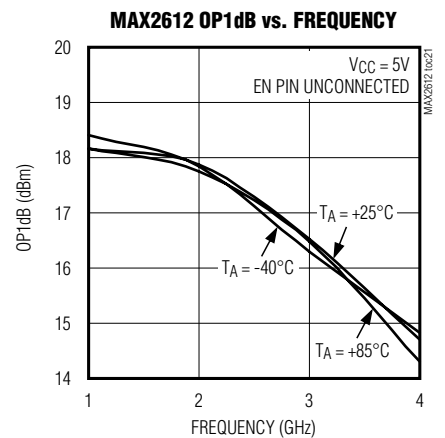
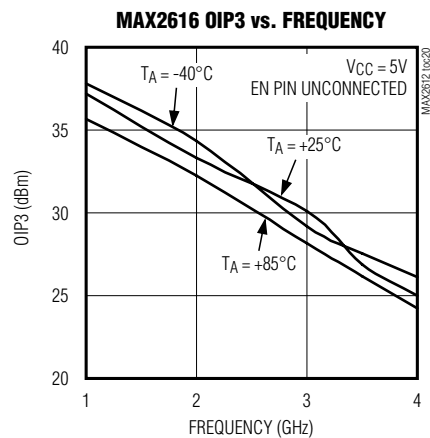
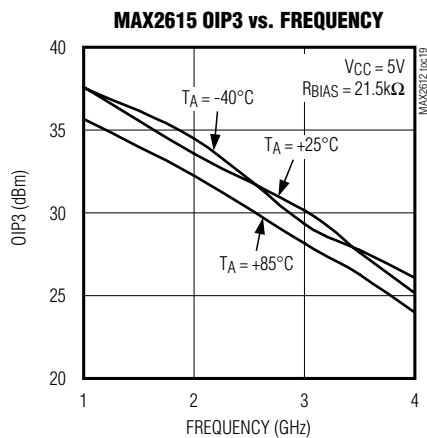
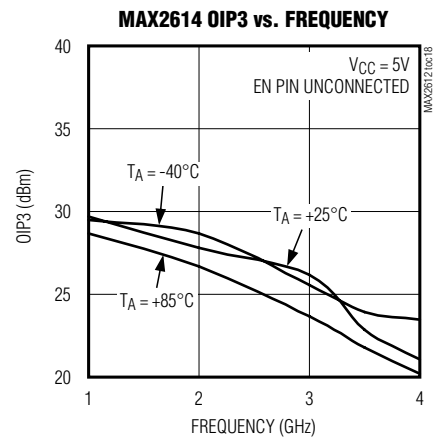
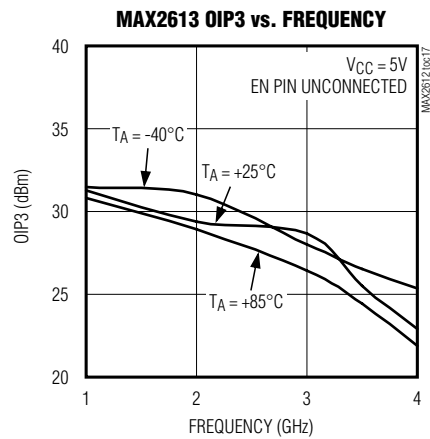
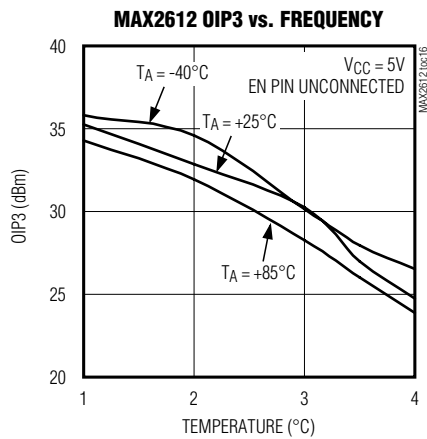
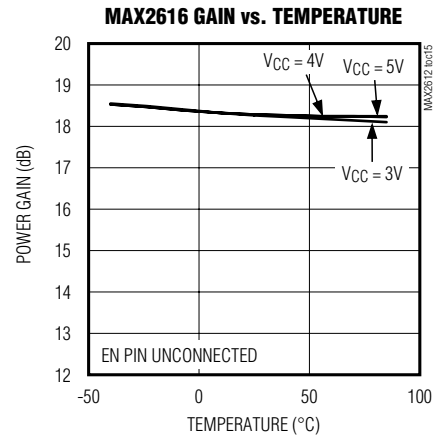
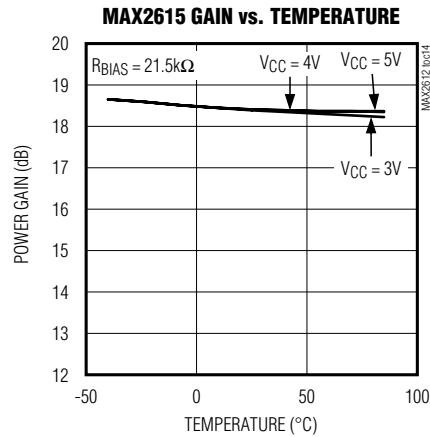
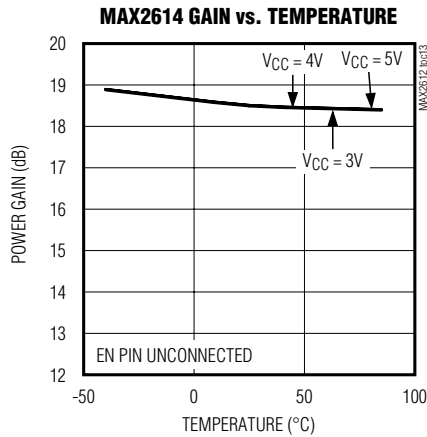

MAX2612-MAX2616

40MHz至4GHz宽带线性放大器

典型工作特性(续)

(MAX2612/MAX2613/MAX2614/MAX2615/MAX2616 EV Kit, $V_{RFOUT} = +5V$, $T_A = +25^\circ C$.)

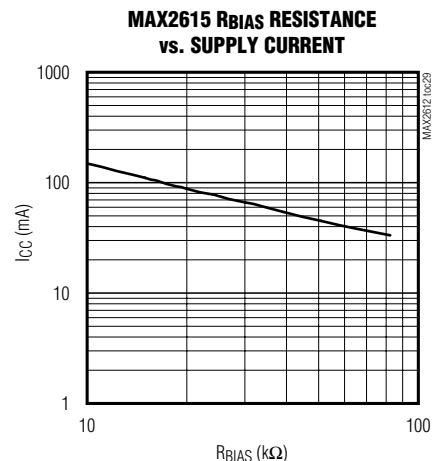
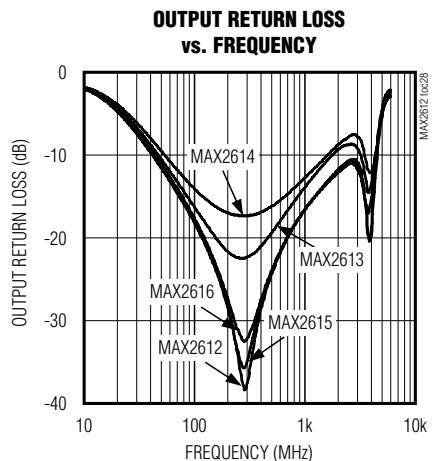
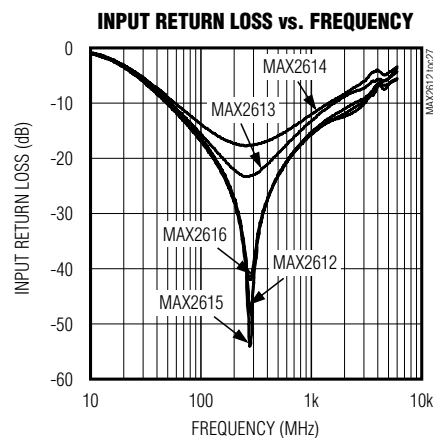
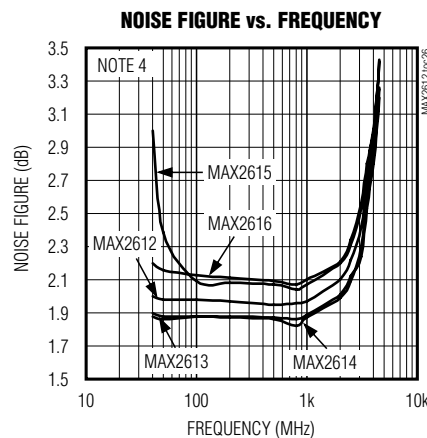
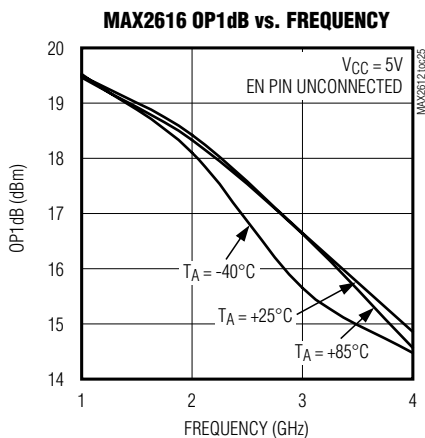
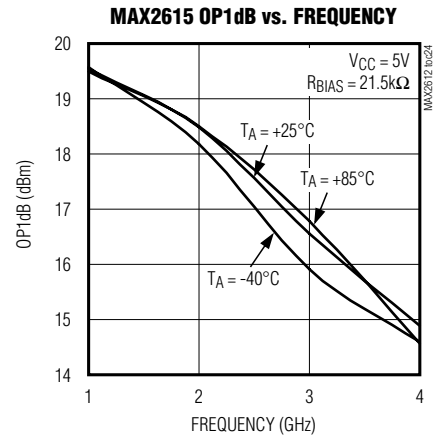
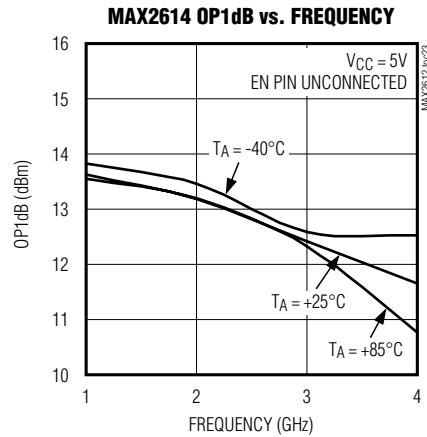
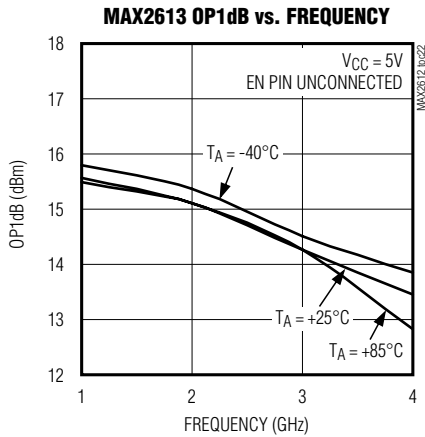

MAX2612-MAX2616

40MHz至4GHz宽带线性放大器

引脚配置

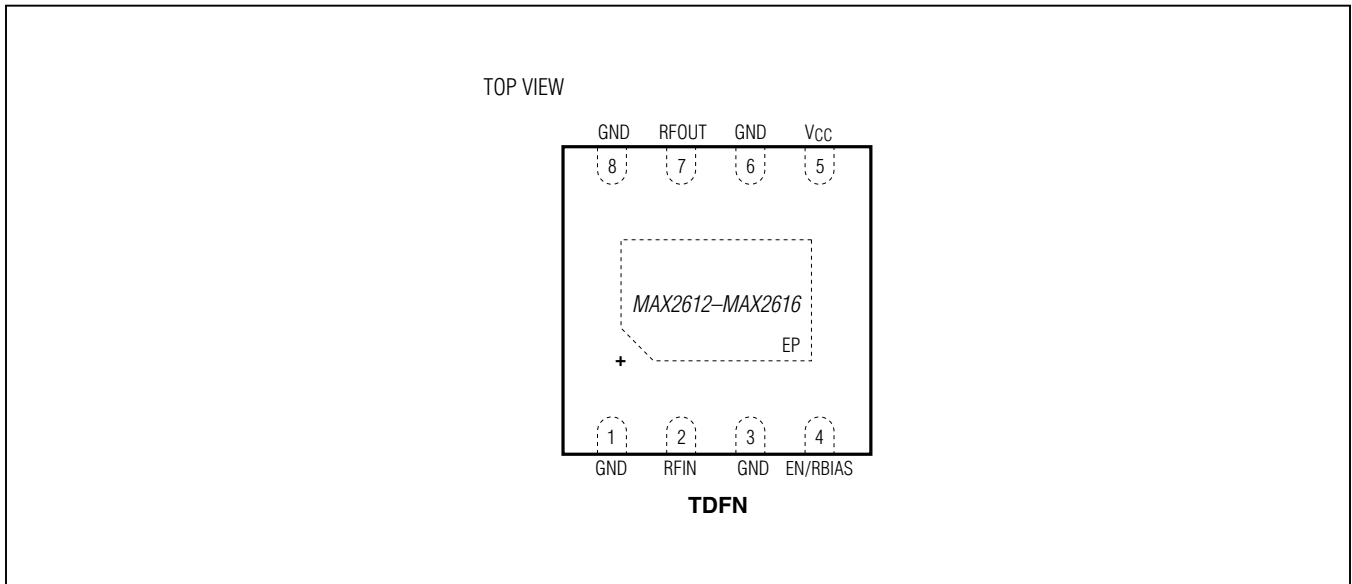

引脚说明

引脚	名称	功能
1, 3, 6, 8	GND	地，连接至PCB接地区域。
2	RFIN	射频输入，利用0.01 μ F隔直电容连接到射频信号源，内部匹配至50 Ω 。
4	EN/RBIAS	使能控制(MAX2612/MAX2613/MAX2614/MAX2616)，保持浮空时工作在常规模式；置于逻辑低电平时，禁止器件工作。对于使用禁用模式的应用，建议由高阻源提供逻辑高电平驱动，例如，未端接的集电极开路输出或三态(高阻)输出。逻辑低电平应为低阻源，或能够吸入10 μ A电流的接地开关。RBIAS (MAX2615)，通过21.5k Ω 偏置电阻接地。调节偏置电阻，以平衡OIP3的供电电流，详细信息请参考应用信息部分。
5	VCC	直流电源输入。安装470pF和10nF去耦电容，电容尽量靠近引脚放置。在VCC上安装10 μ F大容量电容，该电容必须采用钽电容，ESR > 2nF，可安装在较远位置。
7	RFOUT	射频输出和直流供电，通过220nH电感连接至直流电源。利用0.01 μ F隔直电容连接至输出负载。
—	EP	裸焊盘，通过3 x 3过孔阵列连接至PCB接地区域。连接至接地焊盘(1、3、6、8)和第1层接地区域，以改善散热。

MAX2612–MAX2616

40MHz至4GHz宽带线性放大器

详细说明

MAX2615可调节偏压控制

MAX2612/MAX2613/MAX2614/MAX2616采用固定偏压，简单易用；MAX2615可通过RBIAS (引脚4)与地之间的外部电阻控制偏置电流。这种配置下，MAX2615可支持不同应用的电流设置。RBIAS为10kΩ时，电流达到大约150mA的上限；RBIAS为69kΩ时，电流达到大约37.5mA的下限。可调节电流允许优化系统性能和功耗，满足客户要求。

应用信息

宽带设计

对于LTE设计，MAX261x系列能够在整个工作频率范围内保持最小的增益补偿，并保持低噪声、高OIP3性能，采用小尺寸(2mm x 3mm TDFN)、高效散热的封装。器件支持多频段工作，不会降低增益指标，而在pHEMT、InGaP和GaAs放大电路中普遍存在这一潜在的影响。

输入过载处理

MAX261x系列采用简单的达林顿管和可靠的双极型工艺，具有业内领先的+20dBm最大额定输入功率。从根本上省去了输入保护电路，并将潜在的间歇性RF浪涌降至最小。

订购信息

型号	温度范围	引脚-封装
MAX2612ETA+	-40°C to +85°C	8 TDFN-EP*
MAX2613ETA+	-40°C to +85°C	8 TDFN-EP*
MAX2614ETA+	-40°C to +85°C	8 TDFN-EP*
MAX2615ETA+	-40°C to +85°C	8 TDFN-EP*
MAX2616ETA+	-40°C to +85°C	8 TDFN-EP*

+表示无铅(Pb)/符合RoHS标准的封装。

*EP = 裸焊盘。

封装信息

如需最近的封装外形信息和焊盘布局(占位面积)，请查询china.maximintegrated.com/packages。请注意，封装编码中的“+”、“#”或“-”仅表示RoHS状态。封装图中可能包含不同的尾缀字符，但封装图只与封装有关，与RoHS状态无关。

封装类型	封装编码	外形编号	焊盘布局编号
8 TDFN-EP	T823+1	20-0174	90-0091

MAX2612–MAX2616

40MHz至4GHz宽带线性放大器

修订历史

修订号	修订日期	说明	修改页
0	5/12	最初版本。	—

Maxim北京办事处

北京8328信箱 邮政编码100083

免费电话: 800 810 0310

电话: 010-6211 5199

传真: 010-6211 5299



Maxim不对Maxim产品以外的任何电路使用负责，也不提供其专利许可。Maxim保留在任何时间、没有任何通报的前提下修改产品资料和规格的权利。电气特性表中列出的参数值(最小值和最大值)均经过设计验证，数据资料其它章节引用的参数值供设计人员参考。

Maxim Integrated 160 Rio Robles, San Jose, CA 95134 USA 1-408-601-10 00

10