

MAX8686 Evaluation Kit

Evaluates: MAX8686

General Description

The MAX8686 evaluation kit (EV kit) provides a proven design to evaluate the MAX8686 single-phase, high-efficiency, 25A, step-down regulator with integrated switches.

The device is a current-mode, synchronous PWM step-down regulator with integrated MOSFETs, operates from a 6V to 20V input supply, and generates an adjustable output voltage from 0.7V to 5.5V. The switching frequency of the EV kit is set to 500kHz and is programmable from 300kHz to 1MHz. The output voltage is set to 1.5V.

[Ordering Information](#) appears at end of data sheet.

Features

- ◆ Operates from a 6V to 20V Input Supply
- ◆ 0.6V to 5.5V Output Voltage Range
- ◆ All-Ceramic Capacitor Design
- ◆ Programmable Switching Frequency from 300kHz to 1MHz
- ◆ Adjustable Current Limit
- ◆ Adjustable Soft-Start
- ◆ Monotonic Startup to Prebiased Output
- ◆ PCB Supports Additional Second Phase
- ◆ RoHS Compliant
- ◆ Proven PCB Layout
- ◆ Fully Assembled and Tested

Component List

DESIGNATION	QTY	DESCRIPTION
C1	1	390pF ±5%, 50V C0G ceramic capacitor (0402) Murata GRM1555C1H391J
C2, C4, C8	3	10nF ±10%, 50V X7R ceramic capacitors (0402) Murata GRM155R71H103K Taiyo Yuden UMK105BJ103KV
C3	1	150pF ±5%, 50V C0G ceramic capacitor (0402) Murata GRM1555C1H151J TDK C1005C0G1H151J
C5, C19, C21D	0	Not installed, ceramic capacitors
C6, C20, C21A, C21B, C21C, C22–C25, C26A, C26B, C27A, C27B, C28, C29, C100, C201, C202, C203	0	Not installed, ceramic capacitors
C10	1	1000pF±10%, 50V X7R ceramic capacitor (0603) Murata GRM188R71H102K TDK C1608X7R1H102K

DESIGNATION	QTY	DESCRIPTION
C11A–C11D	3	10µF ±10%, 25V X5R ceramic capacitors (1206) Murata GRM31CR61E106K Taiyo Yuden TMK316BJ106KL
C12	1	10pF ±5%, 50V C0G ceramic capacitor (0402) Murata GRM1555C1H100J TDK C1005C0G1H100J
C14	1	4.7µF ±10%, 6.3V X5R ceramic capacitor (0603) Murata GRM188R60J475K TDK C1608X5R0J475K
C15, C16B	2	0.1µF ±10%, 50V X7R ceramic capacitors (0603) Murata GRM188R71H104K TDK C1608X7R1H104K
C16A, C17A	2	1µF ±10%, 25V X5R ceramic capacitors (0603) Murata GRM188R61E105K TDK C1608X5R1E105K
C17B	1	0.1µF ±10%, 16V X5R ceramic capacitor (0402) Murata GRM155R61C104K Taiyo Yuden EMK105BJ104KV

MAX8686 Evaluation Kit

Evaluates: MAX8686

Component List (continued)

DESIGNATION	QTY	DESCRIPTION
C18	1	0.22 μ F \pm 10%, 25V X5R ceramic capacitor (0603) Murata GRM188R61E224K TDK C1608X5R1E224K
C101, C102, C103	3	100 μ F \pm 20%, 6.3V X5R ceramic capacitors (1210) Murata GRM32ER60J107M TDK C3225X5R0J107M
D113	1	Triple diode (SOT26) Central Semi CMXD4448
JP1, JP2	2	2-pin terminal blocks On Shore Tech EDZ500/2DS
JP104, JP106	2	Solder lugs Olander 8C75SPMZR
	2	8-32 x 3/4 slot pans Olander 8CHNTZR
	2	8-32 hex nuts Olander 1485-10
JU1–JU4	4	2-pin headers Sullins PEC36SAAN
JU5	1	3-pin header Sullins PEC36SAAN
L11	0	568nH \pm 20%, 18.5A, dual-phase integrated series inductor TMP SPB-13070-R56-4 GP
L11A	1	0.56 μ H, 49A inductor Vishay IHLP4040DZERR56M01
L11B	0	Not installed, inductor
R1	1	10k Ω \pm 5% resistor (0402)
R2	1	330k Ω \pm 1% resistor (0402)
R3, R4, R19	3	0 Ω \pm 5% resistors (0402)
R5	1	1.5k Ω \pm 1% resistor (0402)
R6, R7, R8, R17, R27, RS100, RS400	0	Not Installed, resistors
R10	1	3.3 Ω \pm 5% resistor (1206)
R11	1	332 Ω \pm 1% resistor (0402)
R12	1	10 Ω \pm 5% resistor (0603)
R13	1	10 Ω \pm 5% resistor (0402)
R14	1	121k Ω \pm 1% resistor (0402)
R15	1	100k Ω \pm 5% resistor (0402)
R16	1	162k Ω \pm 1% resistor (0402)
R18	1	4.7 Ω \pm 5% resistor (0402)
R20–R29	0	Not installed, resistors

DESIGNATION	QTY	DESCRIPTION
U101	1	Single-phase, high-efficiency, 25A, step-down regulator with integrated switches (40 TQFN-EP*) Maxim MAX8686ETL+
U102	0	Not installed, single-phase, high-efficiency, 25A, step-down regulator with integrated switches (40 TQFN-EP*) Maxim MAX8686ETL+
—	1	Shunt (JU5)
—	1	PCB: MAX8686EVKIT+ Rev A
OPTIONAL COMPONENTS		
C6, C27B	2	0.1 μ F \pm 10%, 16V X5R ceramic capacitors (0402)
C20	1	1000pF \pm 10%, 50V X7R ceramic capacitor (0603) Murata GRM188R71H102K
C21A, C21B, C21C	3	10 μ F \pm 10%, 25V X5R ceramic capacitors (1206) Murata GRM31CR61E106K
C22, C29	2	10pF \pm 5%, 50V C0G ceramic capacitors (0402) Murata GRM1555C1H100J
C23	1	22pF \pm 0.5%, 50V C0G ceramic capacitor (0402) TDK C1005C0G1H220J
C24	1	4.7 μ F \pm 10%, 6.3V X5R ceramic capacitor (0603) Murata GRM188R60J475K
C25, C26B	2	0.1 μ F \pm 10%, 50V X7R ceramic capacitors (0603) Murata GRM188R71H104K
C26A, C27A	2	1 μ F \pm 10%, 25V X5R ceramic capacitors (0603) Murata GRM188R61E105K
C28	1	0.22 μ F \pm 10%, 25V X5R ceramic capacitor (1206) Murata GRM188R61E224K
L11B	1	0.56 μ H 49A inductor Vishay IHLP4040DZERR56M01
R20	1	3.3 Ω \pm 5% resistor (1206)
R21	1	332 Ω \pm 1% resistor (0402)
R22	1	10 Ω \pm 5% resistor (0603)

MAX8686 Evaluation Kit

Evaluates: MAX8686

Component List (continued)

DESIGNATION	QTY	DESCRIPTION
R23	1	10Ω ±5% resistor (0402)
R24	1	51.1kΩ ±1% resistor (0402)
R25	1	16.5kΩ ±1% resistor (0402)
R26	1	162kΩ ±1% resistor (0402)
R28	1	47Ω ±5% resistor (0402)
R29	1	0Ω ±5% resistor (0402)

DESIGNATION	QTY	DESCRIPTION
U102	1	Single-phase, high-efficiency, 25A, step-down regulator with integrated switches (40 TQFN-EP*) Maxim MAX8686ETL+

*EP = Exposed pad.

Component Suppliers

SUPPLIER	PHONE	WEBSITE
Central Semiconductor Corp.	631-435-1110	www.centrasemi.com
Murata Electronics North America, Inc.	770-436-1300	www.murata-northamerica.com
Taiyo Yuden	800-348-2496	www.t-yuden.com
TDK Corp.	847-803-6100	www.component.tdk.com
Vishay	402-563-6866	www.vishay.com

Note: Indicate that you are using the MAX8686 when contacting these component suppliers.

Quick Start

Recommended Equipment

- MAX8686 EV kit
- 6V to 20V, 5A DC power supply
- Load capable of 25A
- Digital voltmeter

Procedure

The EV kit is fully assembled and tested. Follow the steps below to verify the board operation. **Caution: Do not turn on power supply until all connections are made.**

- 1) Connect the positive terminal of the 12V supply to the VIN connector (JP1) and the negative terminal to the nearest PGND connector (JP2).
- 2) Connect the positive terminal of the 25A load (max) to the VOUT connectors (JP104) and the negative terminal to the nearest PGND connectors (JP106).
- 3) Connect the digital voltmeter across the output-sensing points (TP_RS+ and TP_RS-).
- 4) Verify that a shunt is installed across pins 2-3 on jumper JU5.
- 5) Verify that shunts are not installed on jumpers JU1–JU4.
- 6) Turn on the DC power supply.
- 7) Verify that the voltmeter displays 1.5V.
- 8) Verify that the power-okay output (JU4) is approximately 5.4V.

Detailed Description of Hardware

The MAX8686 EV kit provides a proven design to evaluate the MAX8686 step-down regulator with integrated switches. The applications include server, point-of-load, ASIC/CPU/DSP, DDR, base station, telecom and networking, and RAID-control power supplies. The EV kit is preset for 1.5V output at load currents up to 25A from a 6V to 20V input supply. The IC features a programmable, fixed switching frequency up to 1MHz that allows the EV kit to support an all-ceramic capacitor design and fast transient responses.

Soft-Start

The IC utilizes an adjustable soft-start function to limit inrush current during startup. The soft-start time is adjusted by the value of C2, the external capacitor from SS to GND. C2 is currently 0.01μF, which gives a soft-start time of approximately 0.6ms. To adjust the soft-start time, determine the C2 value using the following formula:

$$C2 = (25\mu\text{A} \times t_{\text{SS}}) / V_{\text{OUT}}$$

where t_{SS} is the required soft-start time in seconds and C2 is in farads.

When an external reference is applied to REFIN (JU5), soft-start must be provided externally and the external reference source must be able to sink 25μA soft-start current.

MAX8686 Evaluation Kit

Evaluates: MAX8686

Setting the Output Voltage

The output voltage can be programmed by a resistor-divider. Install a shunt on jumper JU5 to use the internal reference voltage (3.3V) generated by the IC. See Table 1 to configure JU5.

The EV kit output can be adjusted from 0.6V to 3.3V by changing the values of resistors R15 and R14. To determine the values of the resistor-divider, first select R15 and then use the following equation to calculate R14, where V_{OUT} is the desired output. The sum of the two resistors should exceed 165k Ω .

$$R14 = R15 \times (3.3V/V_{OUT} - 1)$$

If the desired output voltage is between 3.3V and 5V, set $R14 = 0\Omega$ and add a resistor-divider from V_{OUT} to RS+ and to RS-.

The output voltage can also be programmed by connecting JU5 to an external power supply (up to 3.3V). Connect the positive and negative terminals on JU5 to 1 and 3, respectively.

Regulator Enable (EN1)

To shut down the converter, install a shunt on jumpers JU1 and JU2. For normal operation of the converter, remove the shunt from JU2. See Table 2 to configure jumpers JU1, JU2, and JU3.

Table 1. Internal/External Reference Jumper Description (JU5)

SHUNT POSITION	DESCRIPTION
1-2*	Use internal reference (3.3V) for output voltage programming.
Open	Use external reference for output voltage programming.

*Default position.

Programming the Switching Frequency

The EV kit switching frequency is set to 500kHz. To select a different switching frequency (from 300kHz to 1MHz), change capacitor C1 based on the following equation:

$$C1 = C_{FREQ} - C_{PARA} \\ = (5 \times 10^5 - 30 \times f_{SW}) / (2.7 \times f_{SW}) - C_{PARA}$$

where f_{SW} is the desired switching frequency in kHz, C_{FREQ} is the total capacitance in picofarads, and C_{PARA} is the parasitic capacitance from device pads and PCB traces in picofarads. For this EV kit, the parasitic capacitance is approximately 15pF.

Program the Overcurrent Limit

The overcurrent-limit threshold is set at 25A per phase. To set a different current limit, change resistor R2 based on the following equation:

$$R2 = (I_{LIM} + I_{P-P}/2) \times 6.1 \times R_{DC}$$

Where R2 is in k Ω , I_{LIM} is the desired current limit in amperes, I_{P-P} is the peak-to-peak ripple current in the inductor in amperes, R_{DC} is the DC resistance of the inductor in milliohms, and its dependence on temperature should be included in the calculation. For this design, DCR = 1.7m Ω and increases to 2.1m Ω at +85°C.

For additional information, refer to the MAX8686 IC data sheet at www.maximintegrated.com.

Table 2. Regulator Enable (EN) Jumper Descriptions (JU1, JU2, JU3)

JUMPER	SHUNT POSITION	DESCRIPTION
JU1	1-2	Disables the converter or phase no. 2. It should be combined with JU2 and JU3.
	Open*	Normal operation
JU2	1-2	Disables the converter
	Open*	Normal operation
JU3	1-2	Disables phase no. 2
	Open*	Normal operation of phase no. 2

*Default position.

MAX8686 Evaluation Kit

Evaluates: MAX8686

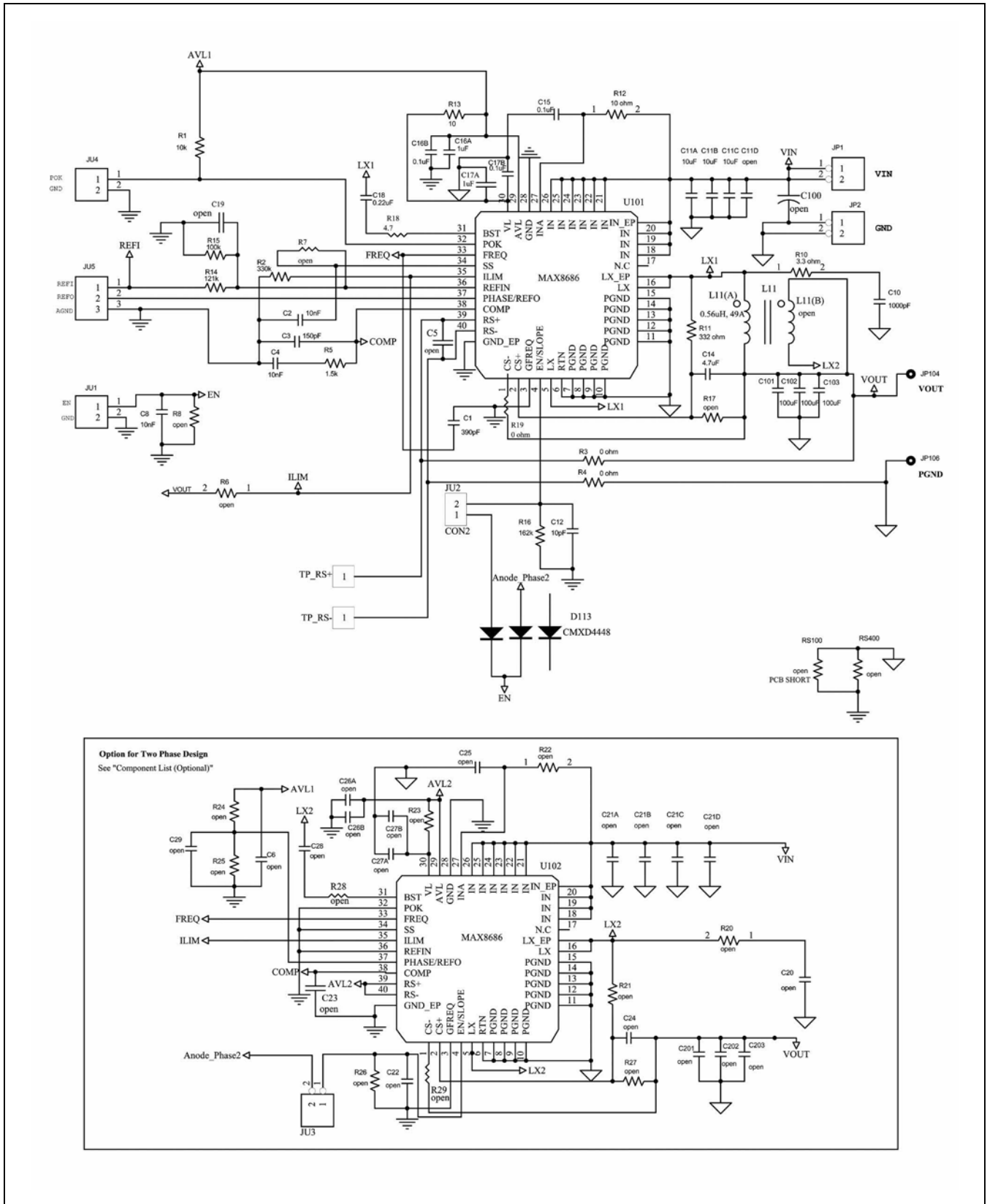

Figure 1. MAX8686 EV Kit Schematic

MAX8686 Evaluation Kit

Evaluates: MAX8686

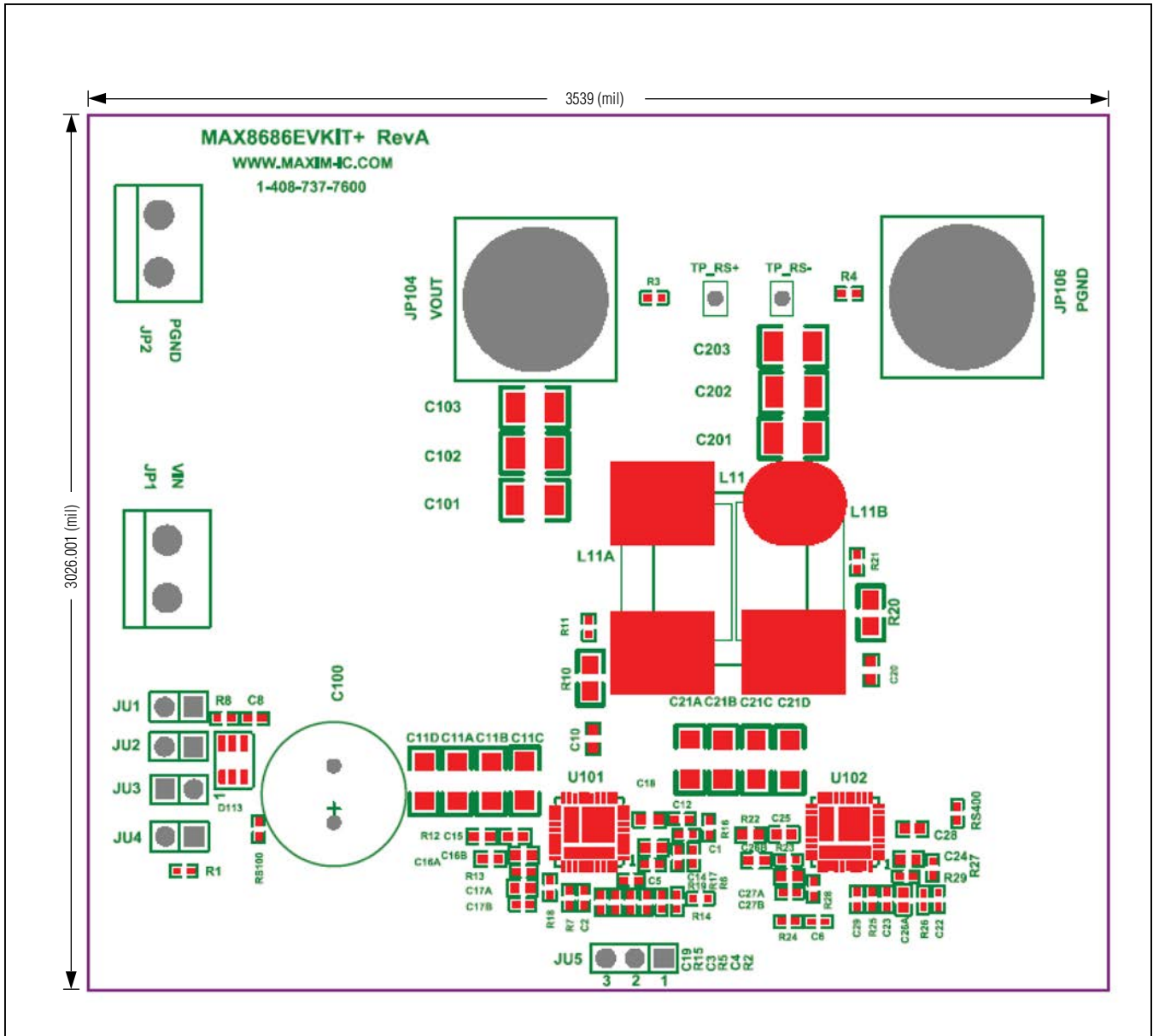

Figure 2. MAX8686 EV Kit Component Placement Guide—Top Silkscreen

MAX8686 Evaluation Kit

Evaluates: MAX8686

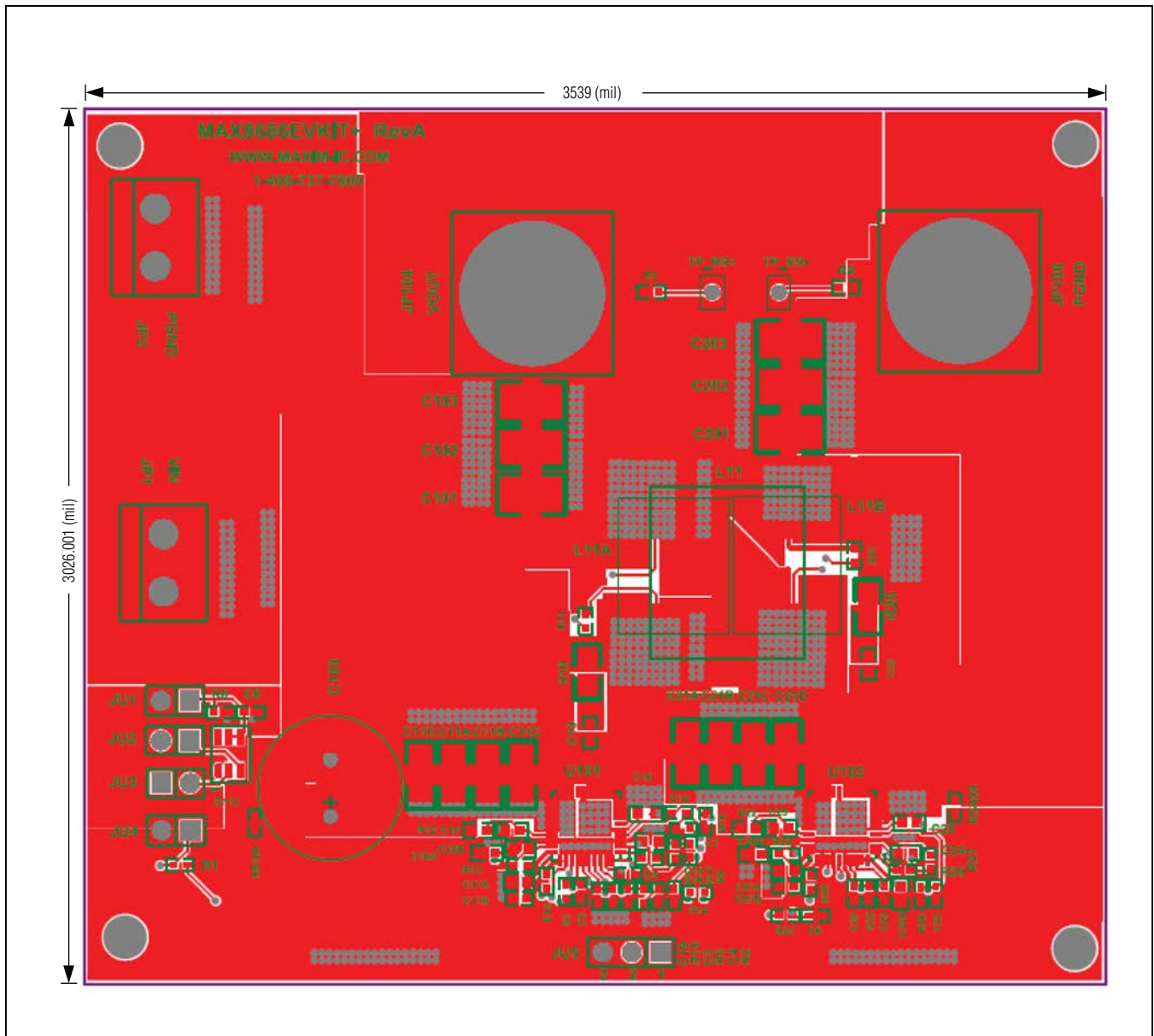

Figure 3. MAX8686 EV Kit PCB Layout—Component Side

MAX8686 Evaluation Kit

Evaluates: MAX8686

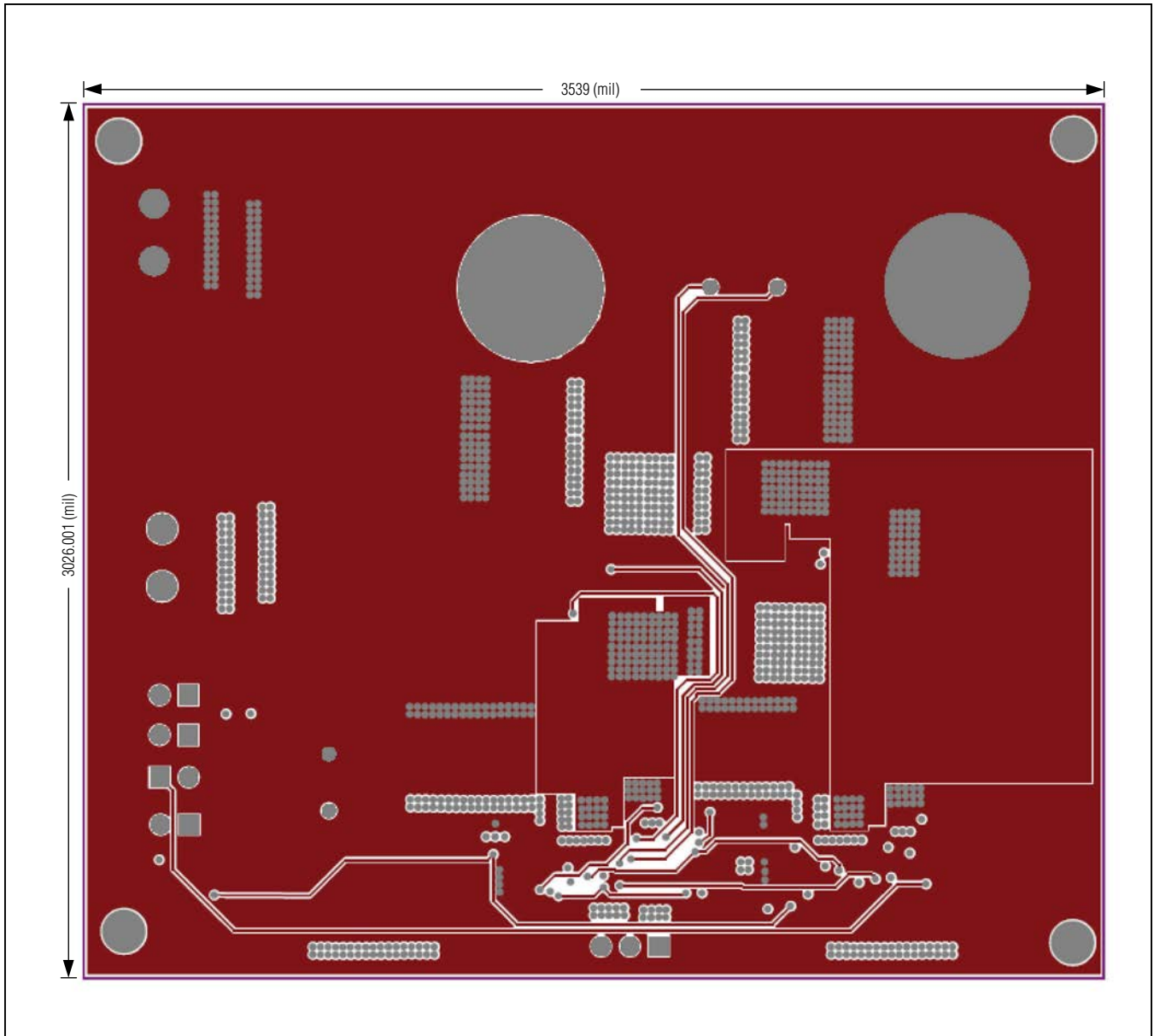

Figure 4. MAX8686 EV Kit PCB Layout—Layer 2 (GND)

MAX8686 Evaluation Kit

Evaluates: MAX8686

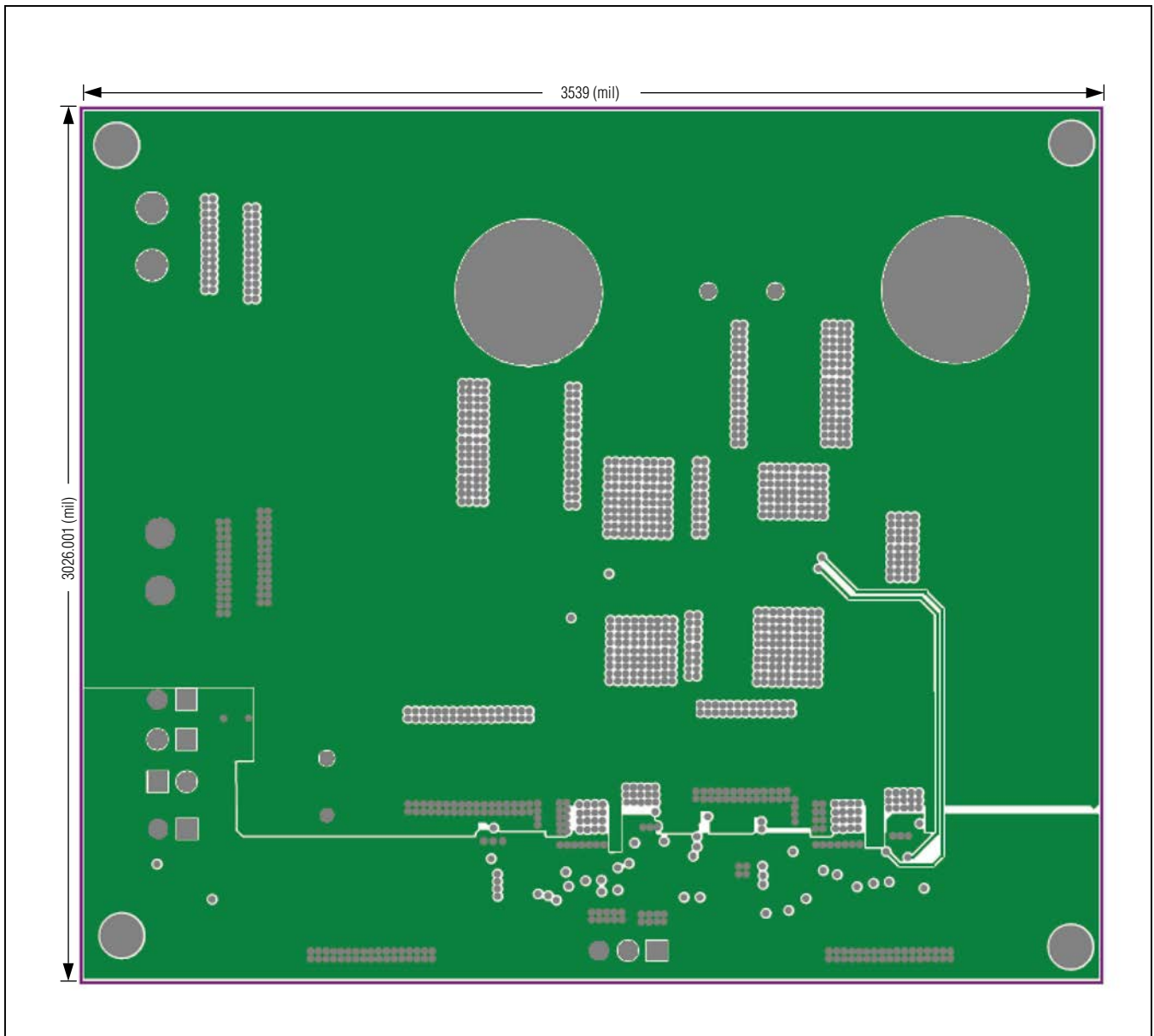

Figure 5. MAX8686 EV Kit PCB Layout—Layer 3 (VIN and AGND)

MAX8686 Evaluation Kit

Evaluates: MAX8686

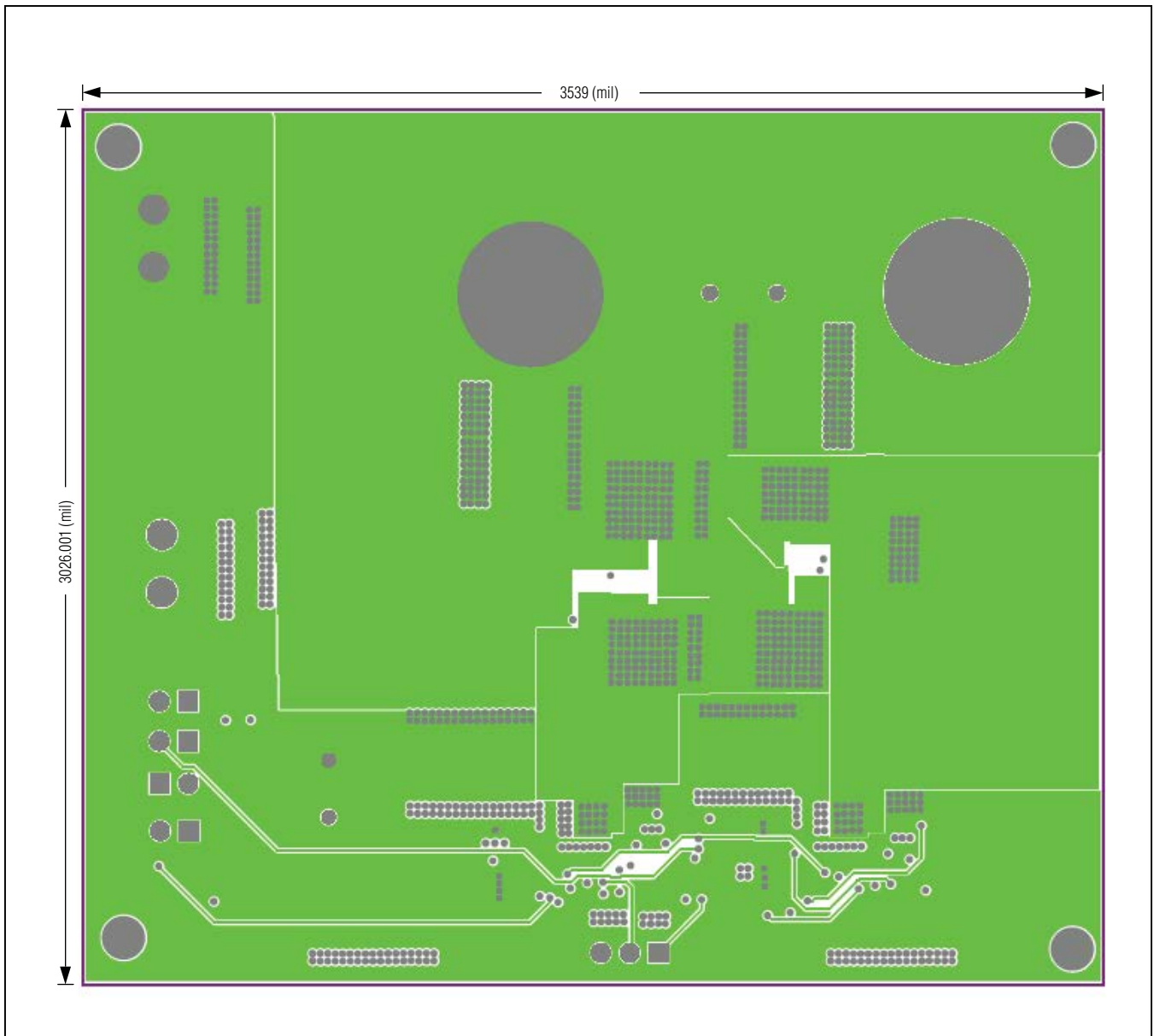

Figure 6. MAX8686 EV Kit PCB Layout—Layer 4 (VOUT, PGND, and LX)

MAX8686 Evaluation Kit

Evaluates: MAX8686

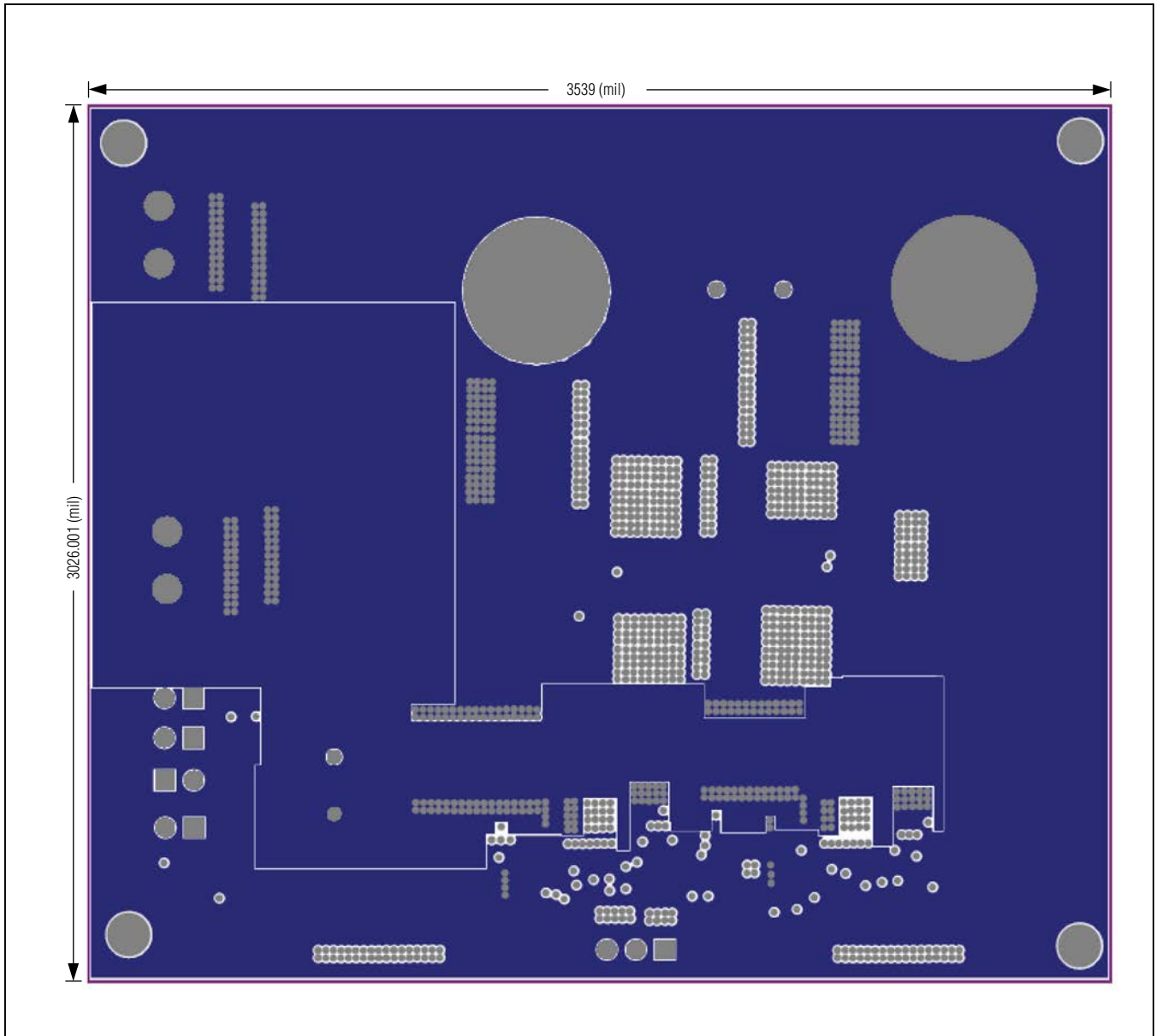

Figure 7. MAX8686 EV Kit PCB Layout—Layer 5 (Signals, VIN, and PGND)

MAX8686 Evaluation Kit

Evaluates: MAX8686

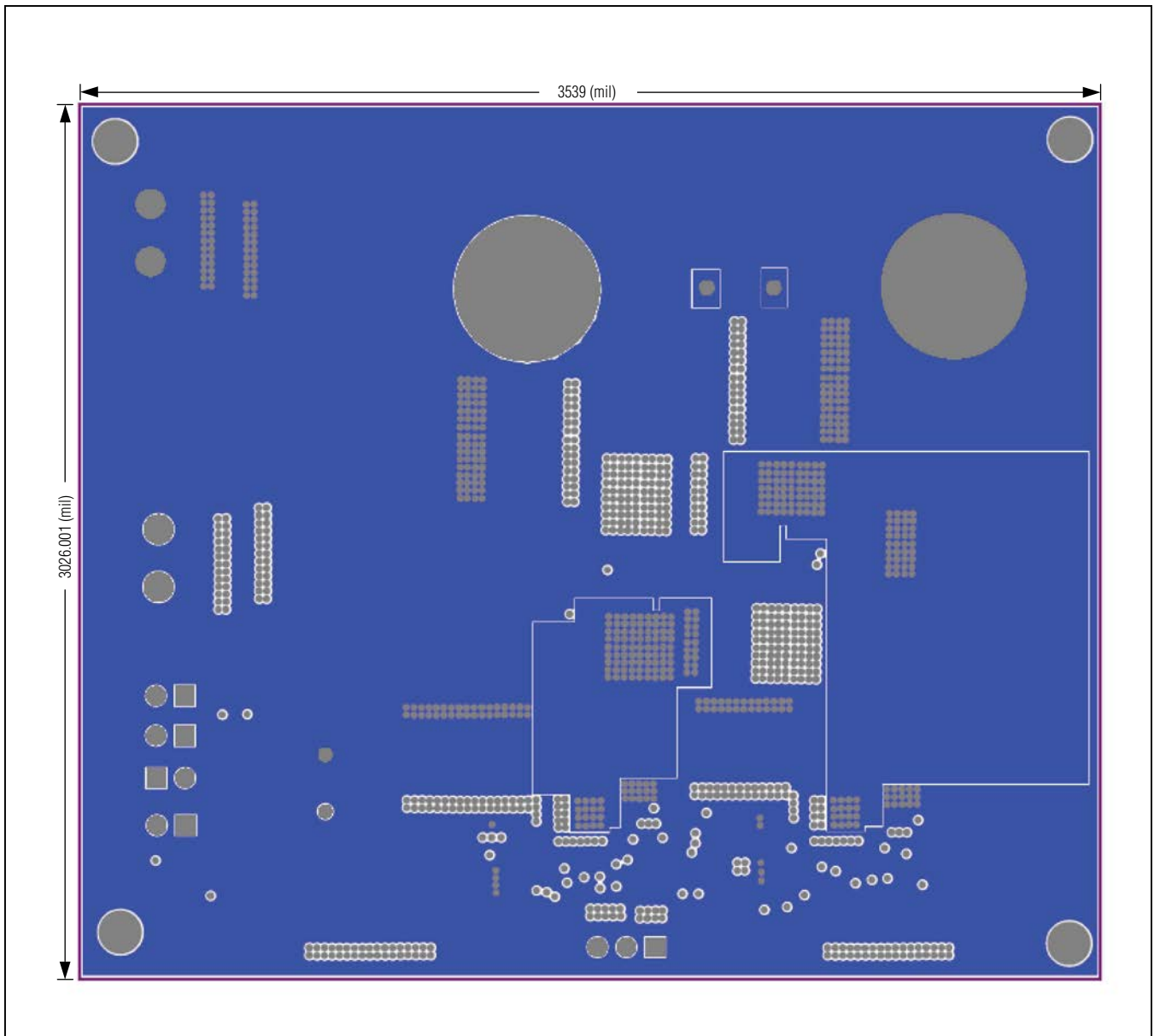

Figure 8. MAX8686 EV Kit PCB Layout—Bottom Layer (PGND and LX)

MAX8686 Evaluation Kit

Evaluates: MAX8686

Ordering Information

PART	TYPE
MAX8686EVKIT#	EV Kit

#Denotes RoHS compliant.

MAX8686 Evaluation Kit

Evaluates: MAX8686

Revision History

REVISION NUMBER	REVISION DATE	DESCRIPTION	PAGES CHANGED
0	5/12	Initial release	—



Maxim Integrated cannot assume responsibility for use of any circuitry other than circuitry entirely embodied in a Maxim Integrated product. No circuit patent licenses are implied. Maxim Integrated reserves the right to change the circuitry and specifications without notice at any time. The parametric values (min and max limits) shown in the Electrical Characteristics table are guaranteed. Other parametric values quoted in this data sheet are provided for guidance.

Maxim Integrated 160 Rio Robles, San Jose, CA 95134 USA 1-408-601-1000

14